

Cuisinart™ INSTRUCTION BOOKLET

Recipe
Booklet
Reverse Side



Cuisinart™ Electric Pressure Cooker **CPC-600 Series**

For your safety and continued enjoyment of this product, always read the instruction book carefully before using.

IB-7077

IMPORTANT SAFEGUARDS

When using electrical appliances, basic safety precautions should always be followed including the following:

1. **Read all instructions.**
2. Do not touch hot surfaces of pressure cooker. Use handles only.
3. Close supervision is necessary when the pressure cooker is used near children. It is not intended for use by children.
4. **NEVER ATTEMPT TO OPEN LID WHILE THE UNIT IS OPERATING.** Do not open the pressure cooker until the unit has cooled and all internal pressure has been released. If lid is difficult to rotate, this indicates that the cooker is still pressurized. Do not force it to open. Any pressure in the cooker can be hazardous. See Operating Instructions, page 5.
5. Do not place the pressure cooker in a heated oven or on any stovetop.
6. Extreme caution must be used when moving a pressure cooker containing hot liquids or foods.
7. Do not use the pressure cooker for other than intended use.
8. This appliance cooks under pressure. Improper use may result in scalding injury. Make certain unit is properly closed before operating. See Operating Instructions, page 5.
9. Do not fill unit over $\frac{3}{4}$ full. When cooking foods that expand during cooking, such as dried vegetables, legumes, beans, and grains, do not fill the unit over $\frac{1}{2}$ full. Overfilling may cause a risk of clogging the pressure limit valve and developing excess pressure.
10. To protect against electrical shock, do not immerse cord, plugs, or outer vessel in water or other liquids.
11. Unplug from outlet when not in use and before cleaning. Allow to cool before putting on or removing parts.

12. Do not operate any appliance with a damaged cord or plug or after the appliance malfunctions or has been damaged in any manner.
13. Do not let cord hang over edge of table or counter, or touch hot surfaces.
14. Use of accessories not specifically recommended by Cuisinart may cause damage to unit.
15. Do not use outdoors.
16. Do not use under hanging cabinets; steam from pressure release may cause damage.
17. Always attach plug to appliance first, before plugging into wall outlet. To disconnect, turn control to "off", then remove plug from outlet.
18. Be aware that certain foods, such as applesauce, cranberries, pearl barley, oatmeal and other cereals, split peas, noodles, macaroni, rhubarb, or spaghetti can foam, froth and sputter, and clog the pressure release devices. These foods should not be cooked in a pressure cooker unless following a Cuisinart™ Electric Pressure Cooker recipe.
19. Always check the pressure release devices for clogging before use.
20. Do not use this pressure cooker for pressure frying oil.

SAVE THESE INSTRUCTIONS FOR HOUSEHOLD USE ONLY

SPECIAL CORD SET INSTRUCTIONS

A short power-supply cord is provided to reduce the risks resulting from becoming entangled in or tripping over a longer cord.

Longer extension cords are available and may be used if care is exercised in their use.

If a long extension cord is used, the marked electrical rating of the extension cord must be at least as great as the electrical rating of the appliance, and the longer cord should be arranged so that it will not drape over the or tabletop where it can be pulled on by children or tripped over.

CONTENTS

Important Safeguards.....	2
Special Cord Set Instructions	2
Introduction	3
Parts and Features	3
Before First Use	4
Instructions for Use.....	4
Operating Instructions.....	5
Pressure Cooker Settings	6
Safety Valves.....	6
Cleaning	7
Troubleshooting.....	7
Warranty	8

INTRODUCTION

You're about to experience a better, faster, and healthier way of cooking. Your Cuisinart™ Electric Pressure Cooker seals in steam to cook hotter and faster, and it seals in nutrients as well. Cook in less water and experience textures and tastes that are simply sensational. Features easy touch-button settings, a countdown timer, and a cooking pot big enough for a pot roast with all the fixings. Enjoy!

11. Power Cord
12. Lid Handle
13. Lid
14. Sealing Ring Supporting Cover
15. Rubber Grommet
16. Upper Ring
17. Control Panel
18. Trivet - Used for some recipes such as desserts. See Recipe Booklet.

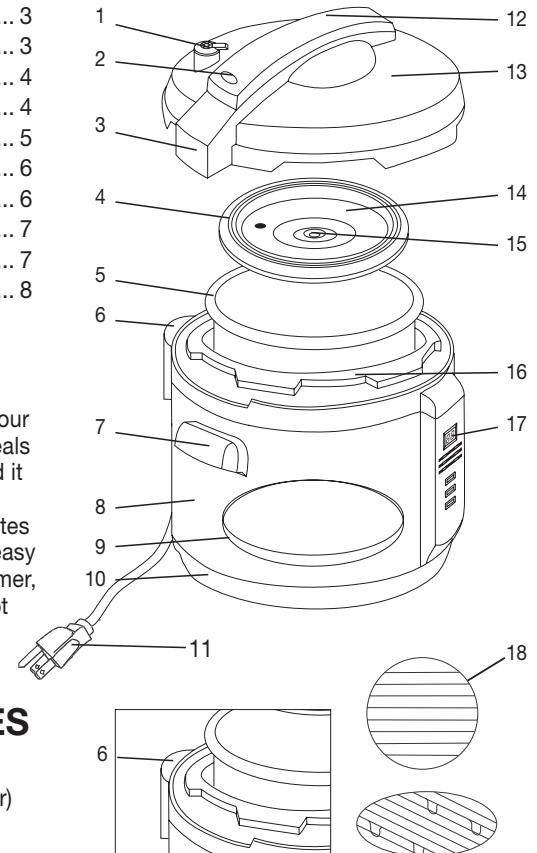

PARTS AND FEATURES

1. Pressure Limit Valve
2. Red Float Valve (Pressure Indicator)
3. Push Rod
4. Sealing Ring
5. Cooking Pot
6. Condensation Collector
7. Handle
8. Outer Body
9. Heating Plate
10. Base

BEFORE FIRST USE

Remove any packaging materials and promotional labels from your electric pressure cooker.

Be sure all parts have been included before discarding any packaging materials. You may want to keep the box and packing materials for use at a later date.

Before using your Cuisinart™ Electric Pressure Cooker for the first time, remove any dust from shipping by wiping clean with a damp cloth. Thoroughly clean the lid and the cooking pot. The cooking pot can be cleaned in the dishwasher or with warm soapy water. Rinse with clean water, towel or air dry, and place into the pressure cooker.

1. Place the pressure cooker on a clean, flat surface where you intend to cook.
2. Place the condensation collector in rear of the unit until it clicks into place (as shown below; also see #6 on diagram, page 3).

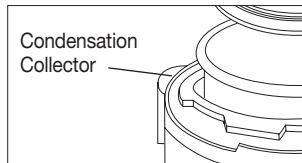

3. Place the pressure limit valve on the lid, as shown in figures 5 and 5a. **Note:** The pressure limit valve does not click or lock into place. Even though it will have a loose fit, it is safely secured.

INSTRUCTIONS FOR USE

Once the pressure cooker is assembled properly, you are ready to begin pressure cooking.

1. To remove lid, grasp handle, turn clockwise and lift.
2. Remove cooking pot from pressure cooker and add food and liquids as the recipe directs. **Note:** The total

volume of food and liquid must not exceed 60% of the capacity of the cooking pot (figure 1). For foods such as dried vegetables and beans, or rice and grains, the total volume must not exceed 50% capacity (figure 2). Always use at least ½ cup liquid when pressure cooking.

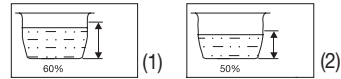

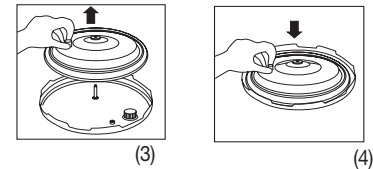

3. To lock the lid in place, remove any food residue from upper rim of cooking pot to ensure a proper seal. Make sure sealing ring is securely in place on sealing ring supporting cover (figure 3). Hold knob on sealing ring supporting cover and press firmly over the center post of inner lid to secure (figure 4). Place lid on pressure cooker and turn it counterclockwise into position.

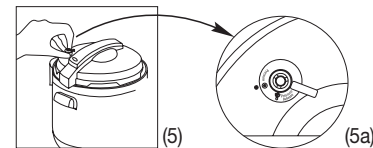

Note: When placing lid on pressure cooker, the float valve should be facing the left.

4. Position the pressure limit valve as directed in figure 5 and 5a, ensuring it is set to the ● position. **Note:** The pressure limit valve does not click or lock into place. Even though it will have a loose fit, it is safely secured. The float in handle must be fully down to properly seal the pot before cooking.



5. Plug the power cord into the pressure cooker and then into the wall outlet. The LED display will show .

OPERATING INSTRUCTIONS

With the unit on and the LED displayed, press the MENU button to select the desired cooking function. The function light will flash.

Select Low or High Pressure setting.

Press TIME to select number of minutes needed for pressure cooking. Time increases in 1-minute increments up to 40 minutes. Time increases in 5-minute increments from 40 to 99 minutes.

Press START/CANCEL to start cooking. The pressure cooker will begin to heat. The red float will rise as pressure builds. When the selected pressure level is reached, the light in lower right-hand corner of LED will stop flashing and remain lit. At this point pressure cooking begins and the timer will start to count down. **The timer will not begin to count down until full pressure is reached, which may be several minutes after the red float has fully risen.**

Note: When cooking under pressure, the red float will rise. The lid is double locked and cannot be opened. NEVER ATTEMPT TO OPEN THE LID WHILE PRESSURE COOKING.

Automatic Keep Warm Feature

When LED display reaches , the pressure cooker automatically shifts to Keep Warm temperature. The Keep Warm light will turn on and unit will beep to indicate cooking is complete.

NOTE: The Keep Warm setting should not be used for more than 12 hours. The quality or texture of the food will begin to change after 1 hour on Keep Warm. In the Keep Warm setting, a little condensation in the upper ring is normal.

To Reset or Cancel

Users can reset the function or cancel the timing setup anytime by pressing the START/CANCEL button.

To Remove Lid

When pressure cooking cycle is finished, the unit will automatically switch to the Keep Warm position. At this point you

may choose to release pressure in 1 of 3 ways – Natural Pressure Release, Quick Pressure Release, or a combination of both. The choice will be dictated by the particular food being cooked and indications in the recipe. If adapting your own recipe for pressure cooking, find a similar recipe in our recipe booklet and use that as a guide.

1. Natural Pressure Release – Following pressure cooking, allow the unit to remain on Keep Warm. The pressure will begin to drop – time for pressure to drop will depend on the amount of liquid in the pressure cooker and the length of time that pressure was maintained. Natural Pressure Release will take from 12 to 30 minutes. During this time cooking continues, so it is recommended for certain cuts of meats, and some desserts. When pressure is fully released, the float (pressure indicator) will drop and the lid will unlock to open.
2. Quick Pressure Release – Following pressure cooking you will hear a series of beeps indicating the process is finished. Turn off and pull the handle of the pressure limit valve forward (see figures 6 and 6a). Do not touch with your hand. Use tongs or another tool.

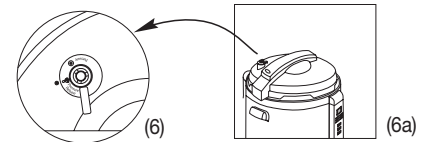

Steam will immediately begin to release through the valve. Keep face and hands away from steam as it is released, and do not release pressure under hanging cabinets, which can be damaged by steam. When pressure is fully released, the pressure indicator will drop and the lid will unlock to open. Using Quick Pressure Release stops the pressure cooking immediately. If further cooking is necessary, the unit may be returned to Pressure, or the food may be further cooked on the Simmer Setting.

3. **Combination Natural Pressure Release and Quick Pressure Release** – For some recipes, we have chosen to use a combination of Natural Pressure Release and Quick Pressure Release. Allow Natural Pressure Release for the time indicated in the recipe (food will continue to cook slightly) followed by Quick Pressure Release.

WARNING: USE EXTREME CAUTION WHEN RELEASING PRESSURE. USE TONGS OR SIMILAR UTENSIL TO PULL HANDLE OF PRESSURE LIMIT VALVE FORWARD.

When the red float is completely down, turn the lid clockwise and lift to remove.

PRESSURE COOKER SETTINGS

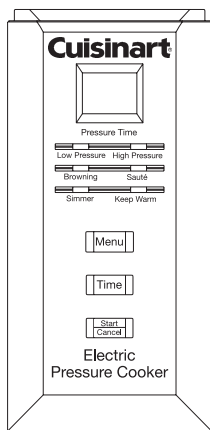

1. **Low Pressure**
2. **High Pressure**
3. **Browning** – This preset temperature allows cooking over high heat, without the lid, before pressure cooking. Browning foods in a small amount of fat in this way seals the outer surfaces of meats and vegetables, producing a visually appealing, flavorful exterior with a moist, tender interior.
4. **Sauté** – The preset temperature, done prior to pressure cooking with lid removed, allows you to quickly soften vegetables in a small amount of fat or liquid without browning, and to cook items such as rice (Arborio, brown, Carnaroli, white, etc.) for pilafs and risottos.
5. **Simmer** – This preset temperature allows you to cook liquids at a lower temperature. It is primarily used to finish cooking some items, i.e. to add ingredients to a risotto, sauce, or

stew or to continue cooking process to achieve preferred texture.

6. **Keep Warm** – Holds and keeps cooked food warm for up to 12 hours (see next page).

SAFETY VALVES

There are seven safety devices installed in the pressure cooker to assure its reliability.

1. **Open-and-Close Lid Safety Device**
The appliance will not start pressurizing until the lid is closed and locked properly.
The lid cannot be opened if the appliance is filled with pressure.
2. **Pressure Control Device**
The correct pressure level is automatically maintained during the cooking cycle.
3. **Pressure Limit Valve**
The pressure limit valve will release air automatically when the pressure inside exceeds the preset temperature.
4. **Anti-Block Cover**
Prevents any food material from blocking the pressure limit valve.
5. **Pressure Relief Device**
When the pressure cooker reaches the maximum allowable pressure and temperature, the cooking pot will move down until lid separates from the sealing ring, releasing air pressure.
6. **Thermostat**
The power will automatically shut off when the cooking pot temperature reaches the preset value, or the pressure cooker is heating without any food inside.
7. **Thermal Fuse**
The circuit will be opened when the pressure cooker reaches the maximum temperature.

CLEANING

1. Unplug the power cord before cleaning.
2. Clean the outer body with a soft cloth such as a paper towel or microfiber cloth. Do not immerse the outer body in water or pour water into it.
3. Rinse with warm water the underside of the lid including the sealing ring, pressure limit valve, anti-block cover, air escape and float valve. Dry completely.
4. Clean area under upper ring with dampened cloth or micro fiber cloth. Do not use chemical cleaners.
5. Cooking pot is dishwasher-safe. To hand-clean the cooking pot, use a soft cloth or sponge and wipe. Be careful not to damage the inside coating. Never use harsh chemicals or scouring pads.
6. To clean sealing ring, hold the knob on the sealing ring supporting cover and pull the sealing ring up. After cleaning, put the sealing ring supporting cover back.

Note: The side with the knob should face outward. Do not put it upside down (figures 7 and 8).

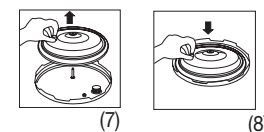

7. To clean rubber grommet located in center of sealing ring supporting cover, carefully remove the sealing ring supporting cover and clean the grommet, then replace it.

8. To clean the pressure limit valve, remove and rinse it with water, then replace it (figure 9).

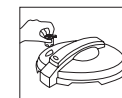

9. To clean the condensation collector, remove and clean it with warm soapy water, then reinstall it.

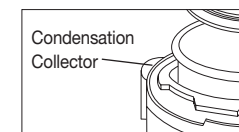

TROUBLESHOOTING

Symptom	Possible Reasons	Solutions
Lid does not lock	The ring is not properly installed	Reinstall the ring
	The float is seized by the push rod	Push the rod with hands
Cannot open the lid after air exhaust	The float is still up	Press the float down
Air escapes from the rim of the lid	No sealing ring was installed	Install the sealing ring
	Food residue on sealing ring	Clean sealing ring
	Sealing ring worn out	Replace the sealing ring
Air escapes from the float valve	Lid not locked properly	Rotate lid fully
	Food stuck on the sealing ring of the float valve	Clean the sealing ring
	The sealing ring on the float wore out	Replace the sealing ring
The float will not rise	The pressure limit valve is not placed properly	Place the device to Pressure ●
	Not enough food and water	Check recipe for proper quantity
	Air escaping from the rim of the lid and the pressure limit valve	Call our Consumer Service Center toll free at 1-800-726-0190

WARRANTY

LIMITED THREE-YEAR WARRANTY

This warranty is available to consumers only. You are a consumer if you own a Cuisinart™ Electric Pressure Cooker that was purchased at retail for personal, family or household use. Except as otherwise required under applicable law, this warranty is not available to retailers or other commercial purchasers or owners.

We warrant that your Cuisinart™ Electric Pressure Cooker will be free of defects in materials and workmanship under normal home use for 3 years from the date of original purchase.

We suggest you complete and return the enclosed product registration card promptly to facilitate verification of the date of original purchase. However, return of the product registration card does not eliminate the need for the consumer to maintain the original proof of purchase in order to obtain the warranty benefits. In the event that you do not have proof of purchase date, the purchase date for purposes of this warranty will be the date of manufacture.

If your Cuisinart™ Electric Pressure Cooker should prove to be defective within the warranty period, we will repair it, or if we think necessary, replace it. To obtain warranty service, simply call our toll-free number 1-800-726-0190 for additional information from our Customer Service Representatives, or send the defective product to Customer Service at Cuisinart, 150 Milford Road, East Windsor, NJ 08520.

To facilitate the speed and accuracy of your return, please enclose \$10.00 for shipping and handling of the product.

Please pay by check or money order (California residents need only supply proof of purchase and should call 1-800-726-0190 for shipping instructions).

NOTE: For added protection and secure handling of any Cuisinart® product that is being returned, we recommend you use a traceable, insured delivery service. Cuisinart cannot be held responsible for in-transit damage or for packages that are not delivered to us. Lost and/or damaged products are not covered under warranty. Please be sure to include your return address, daytime phone number, description of the product defect, product model number (located on bottom of product), original date of purchase, and any other information pertinent to the product's return.

Your Cuisinart™ Electric Pressure Cooker has been manufactured to the strictest specifications and has been designed for use with the authorized accessories and replacement parts.

This warranty expressly excludes any defects or damages caused by accessories, replacement parts, or repair service other than those that have been authorized by Cuisinart.

This warranty does not cover any damage caused by accident, misuse, shipment or other ordinary household use.

This warranty excludes all incidental or consequential damages. Some states do not allow the exclusion or limitation of these damages, so they may not apply to you.

CALIFORNIA RESIDENTS ONLY:

California law provides that for In-Warranty Service, California residents have the option of returning a nonconforming product (A) to the store where it was purchased or (B) to another retail store which sells Cuisinart products of the same type.

The retail store shall then, at its discretion, either repair the product, refer the consumer to an independent repair facility, replace the product, or refund the purchase price less the amount directly attributable to the consumer's prior usage of the product. If the above two options do not result in the appropriate relief to the consumer, the consumer may then take the product to an independent repair facility if service or repair can be economically accomplished. Cuisinart and not the consumer will be responsible for the reasonable cost of such service, repair, replacement, or refund for nonconforming products under warranty.

California residents may also, according to their preference, return nonconforming products directly to Cuisinart for repair, or if necessary, replacement, by calling our Consumer Service Center toll-free at 1-800-726-0190.

Cuisinart will be responsible for the cost of the repair, replacement, and shipping and handling for such products under warranty.

©2006 Cuisinart
Cuisinart® is a registered
Trademark of Cuisinart

150 Milford Road
East Windsor, NJ 08520
Printed in China

06CU26320